



1036-105 ORAS SAFIRA ECO UTILITY ROOM FAUCET

SINGLE-LEVER

EAN: 6414150100000 static.oras.com/1036-105



- Industry, ECO Building, Housing
- Wall mounted
- Chrome
- Swivel spout
- Single operating lever/handle, Hot/Cold symbols
- Limitation option for maximum temperature and flow-rate
- ø 40 mm ceramic cartridge for flow and temperature control

TECHNICAL DATA

FLOW PROPERTIES

Flow-rate at 300 kPa (with flow controller) **0.07 l/s**

TECHNICAL PROPERTIES

Hot water supply **max. +80°C**
Working pressure **50 - 1000 kPa**
Connection size **G3/4**
Installation width **150 ± 3 mm**
Projection **200 mm**
Backflow prevention (EN1717) **AA**
Material **Brass**

REGULATIONS

EN standard **EN 817**
Noise class **I (ISO 3822) Oras lab.**

APPROVALS AND DECLARATIONS

STF certificate **EUFI29-22005196-TH**
Declaration of conformity **DoC**
EPD **S-P-06396**

SUSTAINABILITY

EPD module A1-A3 (kg CO2 eq.) **10,62**
EPD module A4 (kg CO2 eq.) **0,21**
EPD module B7 (kg CO2 eq.) **1654,80**
EPD module C2 (kg CO2 eq.) **0,02**
EPD module C3 (kg CO2 eq.) **0,02**
EPD module C4 (kg CO2 eq.) **0,32**
EPD module D (kg CO2 eq.) **-6,00**

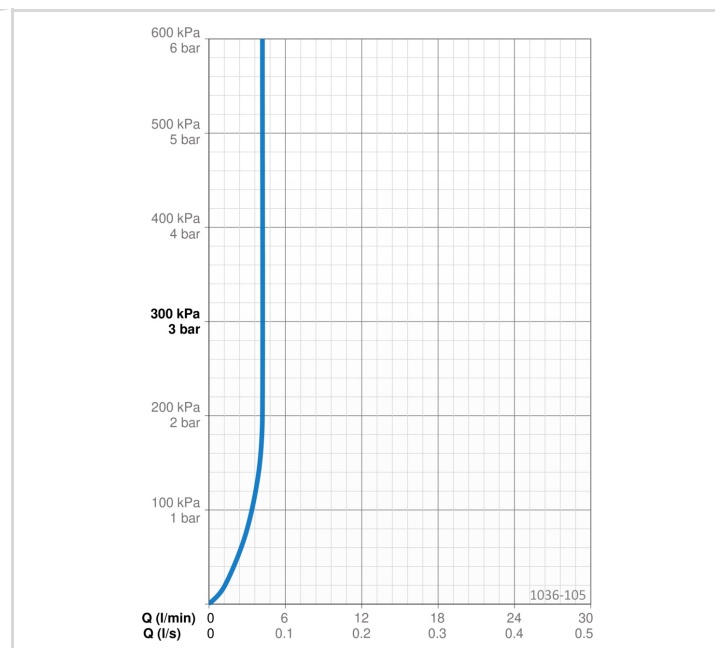
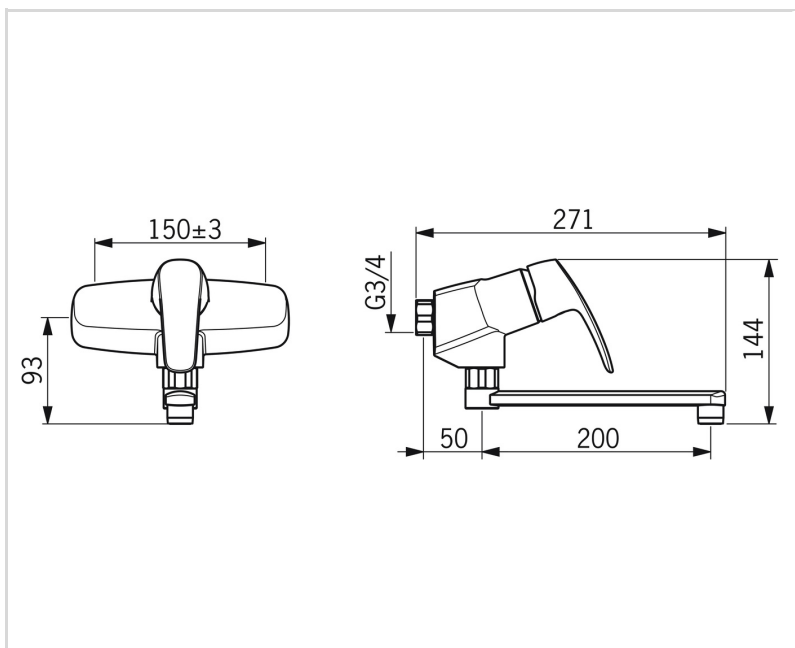

SPARE PARTS

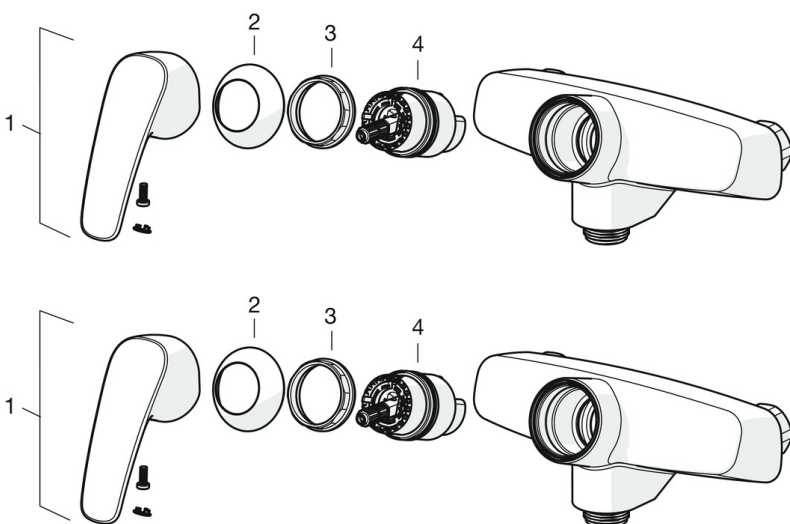

SP1070

Name	Code
01 Lever Chrome	602502V
02 Covering cap Chrome	1000785V
03 Tightening nut, M42x1.5, SW 38	158726
04 Cartridge	158890

SP0044

Name	Code
01 O-ring, 13.6x2.4	469360/10
02 Bushing (10 pcs), 18/20.6 Chrome	219595/10
03 Retaining ring (10 pcs)	219563/10
04 Aerator, M22x1 HC B Chrome	232201