



The perfect combination of style and function. This washbasin faucet from the Stela design line is the perfect new edgy addition to your bathroom. Its chrome surface treatment adds a touch of elegance to any washbasin. The single-lever, top-operating faucet with hot and cold symbols and fixed spout make it easy to use. The bidetta hand shower provides added convenience. The inner body is made of corrosion resistant brass, ensuring durability and longevity. This deck-mounted faucet is perfect for any washbasin installation. Upgrade your bathroom with this timeless elegance for any bathroom design.

- ECO Building
- Deck mounted
- Chrome
- Fixed spout
- PCA® - constant flow rate regardless of pressure variations
- Single operating lever/handle, Hot/Cold symbols
- Hand shower, Shower holder, Shower hose (1750 mm)
- Bidetta hand shower
- Limitation option for maximum temperature and flow-rate
- ø 40 mm ceramic cartridge for flow and temperature control
- Flexible inlet pipes
- Inner body made of DZR brass
- Without pop-up waste
- 1 spray function

TECHNICAL DATA

FLOW PROPERTIES

Flow-rate at 300 kPa (with flow controller) **0.07 l/s**

TECHNICAL PROPERTIES

DN-size (nominal dimension) **DN15**
 Hot water supply **max. +70°C**
 Working pressure **50 - 1000 kPa**
 Connection size **G3/8**
 Projection **107 mm**
 Backflow prevention (EN1717) **HC**
 Material **Brass**

REGULATIONS

EN standard **EN 817**
 Noise class **I (ISO 3822)**

APPROVALS AND DECLARATIONS

STF certificate **EUF129-21003824-TH**
 KIWA SE **1746**
 Declaration of conformity **DoC**
 EPD **S-P-06391**

SUSTAINABILITY

EPD module A1-A3 (kg CO2 eq.) **13,14**
 EPD module A4 (kg CO2 eq.) **0,36**
 EPD module B7 (kg CO2 eq.) **1297,80**
 EPD module C2 (kg CO2 eq.) **0,02**
 EPD module C3 (kg CO2 eq.) **0,03**
 EPD module C4 (kg CO2 eq.) **0,10**
 EPD module D (kg CO2 eq.) **-9,35**

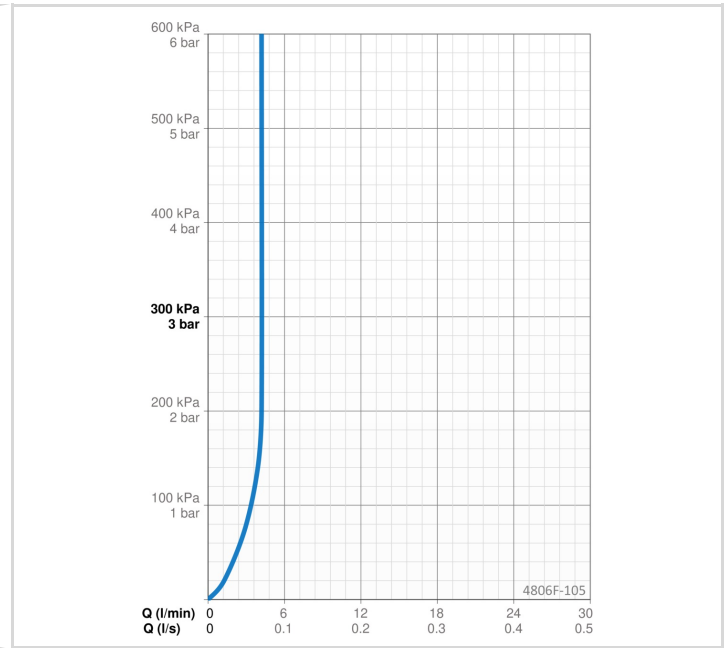
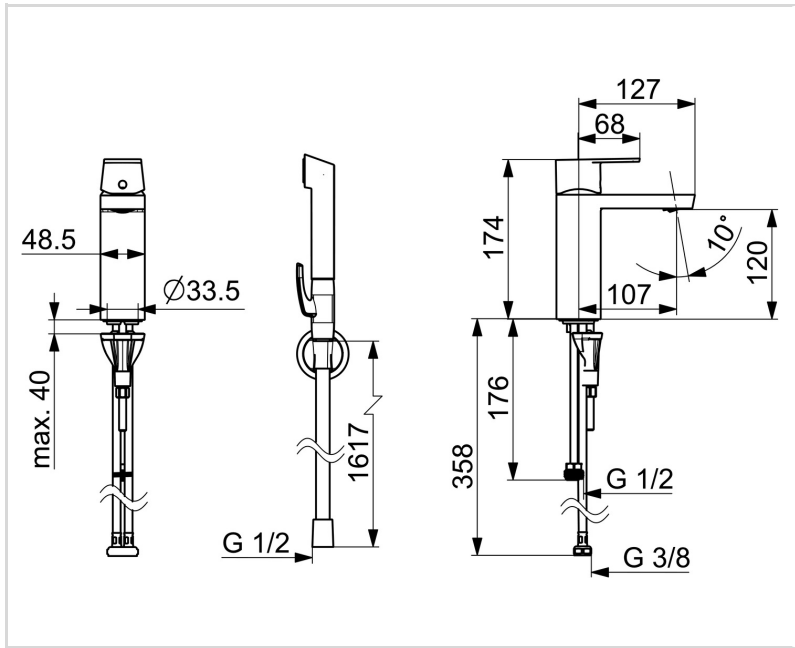

SPARE PARTS

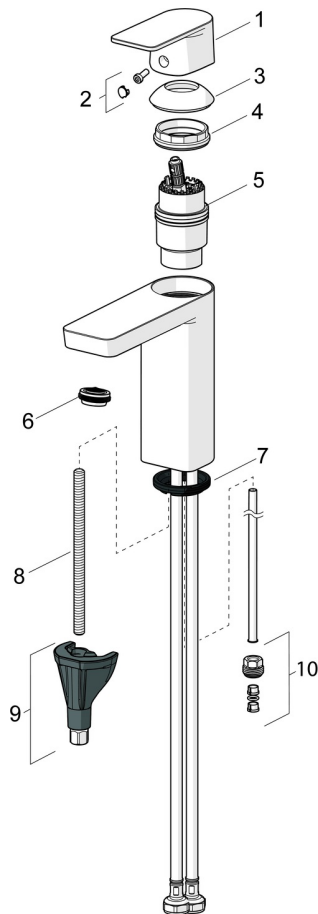

SP4806F-GB

Name	Code
01 Lever Chrome	1006282V
02 Symbol plug	1002323V
03 Covering cap Chrome	1001740V
04 Tightening nut, M42x1.5, SW 38	158726
05 Cartridge	158890
05 Cartridge, Green building	600979V
06 Aerator, STD M24x1 HC PCA 3.8 l/min	1013541V
06 Aerator, STD M24x1 HC PCA 4.6 l/min	1013547V
07 Bottom seal	1002371V
08 Fixing screw, M8x1, L=130	1000780V
09 Fixing set	602610V
10 Nipple	159684