



6335FTZ ORAS ELECTRA WASHBASIN FAUCET, 9/12 V, BLUETOOTH

TOUCHLESS, BLUETOOTH®, PLUG TRANSFORMER

EAN: 6414150096549 static.oras.com/6335FTZ



- Public & Semi-public
- Deck mounted
- Chrome
- Fixed spout
- Hidden aerator
- Temperature control handle
- Adjustable hot water stop (included, retrofittable)
- Mixing valve for manual temperature control, Non-return valve(s), Litter filter(s)
- Autofocus infrared sensor, Solenoid valve, Power supply
- Flexible inlet pipes
- Software settings adjustable via App

TECHNICAL DATA

FLOW PROPERTIES

Flow-rate at 300 kPa (with flow controller)	0.1 l/s
Pressure loss with flow (0.1 l/s)	200 kPa

TECHNICAL PROPERTIES

Hot water supply	max. +70°C
Working pressure	100 - 1000 kPa
Connection size	G3/8
Projection	170 mm
Backflow prevention (EN1717)	AA
Material	Brass

SOFTWARE SETTINGS

Afterflow period	3 s (1-20 s)
Automatic flush	off (off/1-120 h)
Automatic flush period	30 s (1-1800 s)
Max. flow period	2 min (1 - 1800 s)

ELECTRONIC PROPERTIES

Electrical Connection	230 / 9 V
Bluetooth version	4.x (D034445)

REGULATIONS

EU Directives	CE Radio Equipment Directive 2014/53/EU , Low Voltage Directive 2014/35/EU , EMC Directive 2014/30/EU , RoHS Directive 2011/65/EU
EN standard	EN 15091, ETSI EN 301 489-1 V1.9.2 , ETSI EN 300 328 v2.2.2, EN 18031-1, EN 61000-6-1:2007 , EN 61000-6-3:2007+A1:2011+AC:2012 , EN 60335-1:2012+A11+A13+A14+A15:2021, Part 19.11.4
Noise class	I (ISO 3822)
Protection class	IP 55 / transformer IP 20

APPROVALS AND DECLARATIONS

STF certificate	EUFI29-21002459-TH1
Declaration of conformity	RED
EPD	S-P-06394

SUSTAINABILITY

EPD module A1-A3 (kg CO2 eq.)	10,91
EPD module A4 (kg CO2 eq.)	0,44
EPD module B7 (kg CO2 eq.)	430,00
EPD module C2 (kg CO2 eq.)	0,02
EPD module C3 (kg CO2 eq.)	0,02
EPD module C4 (kg CO2 eq.)	0,29
EPD module D (kg CO2 eq.)	-7,90

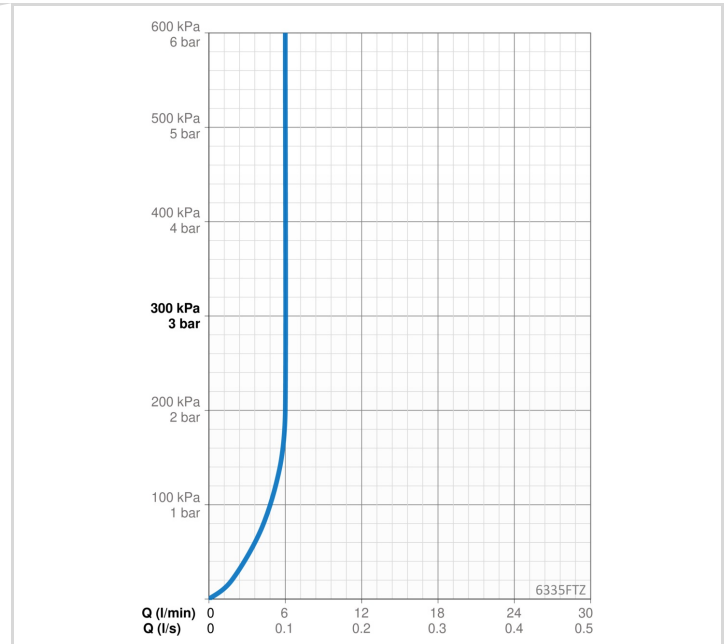
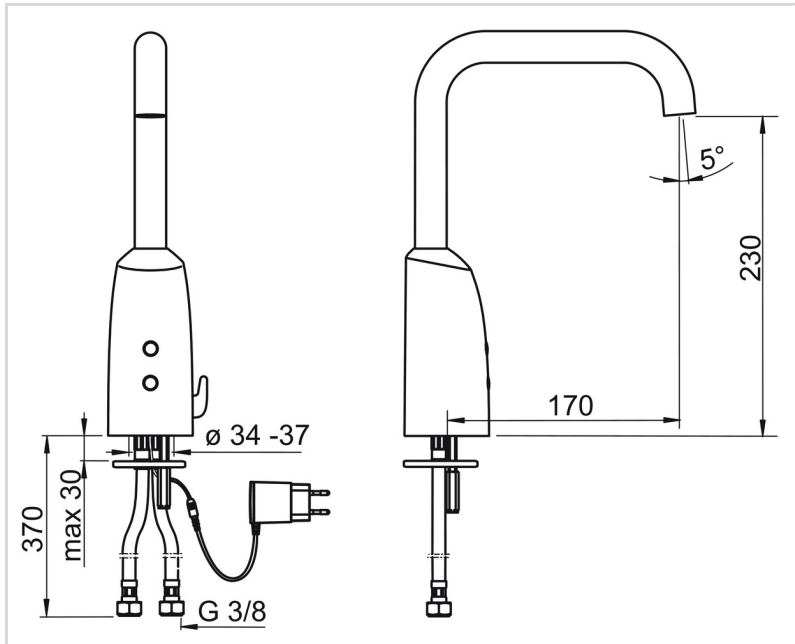

SPARE PARTS

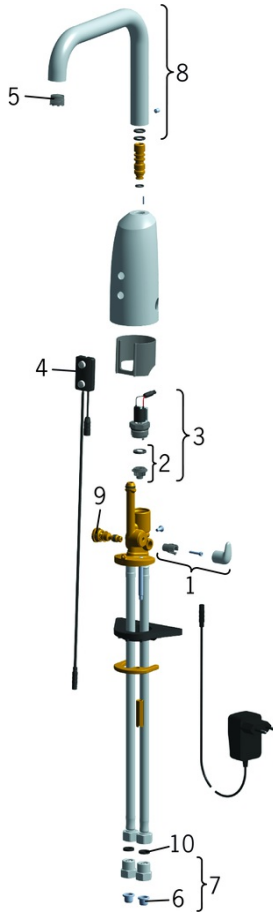

SP6335FT

	Name	Code
01	Temperature control handle Chrome	600581V
02	Membrane support ring Discontinued	199205V
02	Membrane for solenoid valve	1006500V
03	Solenoid valve, 6 V	199206V
04	Sensor, 12 V Discontinued	600780V
04	Sensor, 6/9/12 V Bluetooth	1005063V
05	Aerator and key, M18.5x1 Z	600961V
06	Litter filters	199257/2
07	One-way valve with litter screen Chrome	198473/2
08	Spout, L=181	600724V
09	Temperature regulator	199201V
10	Gasket, 8x14.3x2	600705/10
N.I.	Limiter	601061V